



crealco | CASEMENT 38

WINDOW (38mm)

Profiles

Elevations & Sections

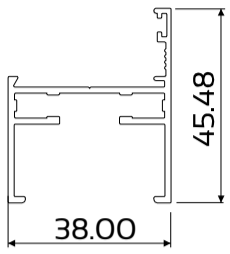

DIE No. W32070 Cas38 Equal Leg Outer Frame

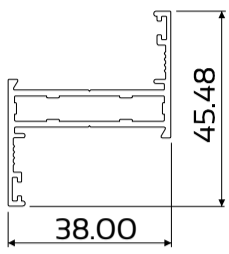

DIE No. W55717 Cas38 Tubular Sash

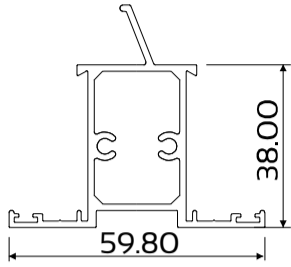

DIE No. W13408 Transom with Weather Bar

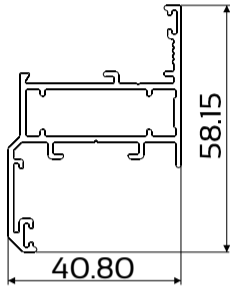

DIE No. W57508 Cas38 Sash Euro

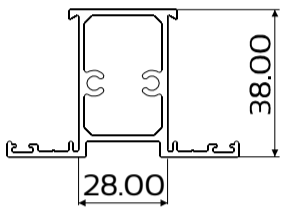

DIE No. W13268 Cas38 Mullion /Transom

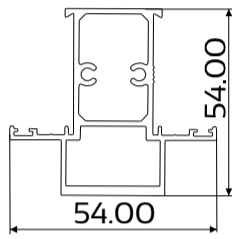

DIE No. W56796 Cas38 54mm Mullion

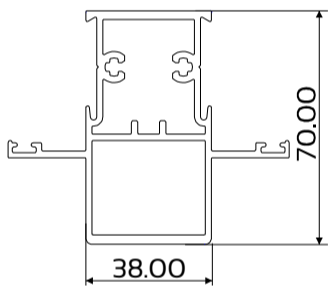

DIE No. W56797 Cas38 70mm Mullion

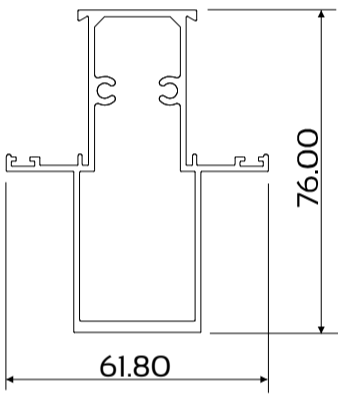

DIE No. W54455 Cas38 76mm Mullion

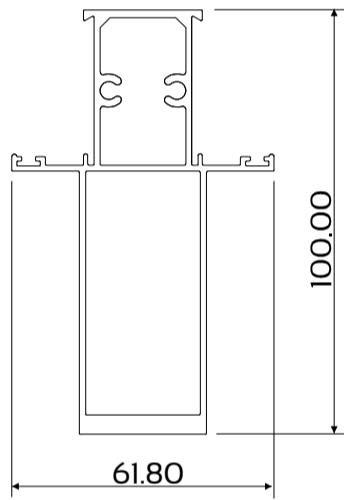

DIE No. W54454 Cas38 100mm Mullion

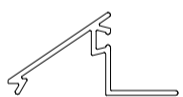

DIE No. W25200 Cas38 Glazing Bead 7-8mm

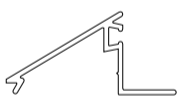

DIE No. W24530 Cas38 Glazing Bead 3-5mm



DIE No. W30312 Double Glazing Bead 25mm



DIE No. W31140 Cas38 Angle Bead 13mm Gap



DIE No. W35510 Cas38 Bead Euro 13mm Gap



DIE No. W29247 Colonial Bar

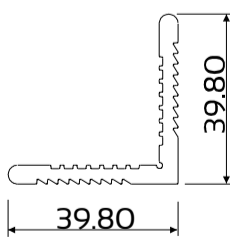

DIE No. W52538 Osborne Multi Corner Cleat

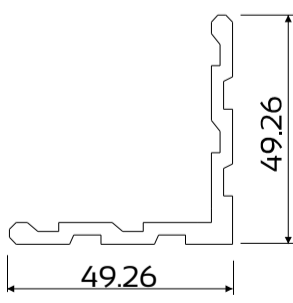

DIE No. W52695 50mm Corner Cleat

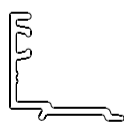

DIE No. W36021 Cas 36 Bead Euro D/G 31mm

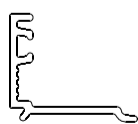

DIE No. W36022 Cas 36 Bead Euro D/G 31mm Gap

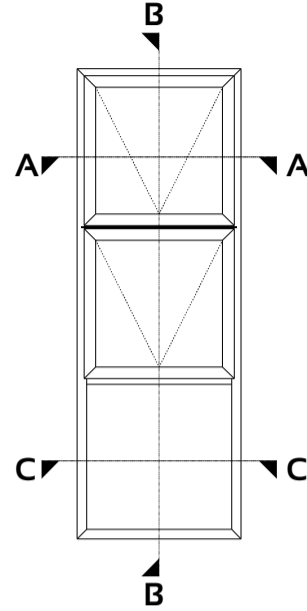

SECTION A-A
Section not to scale

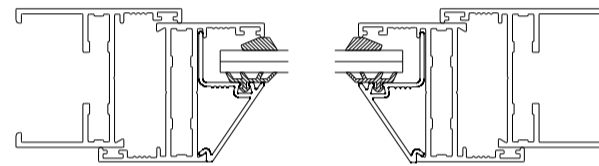

SECTION C-C
Section not to scale

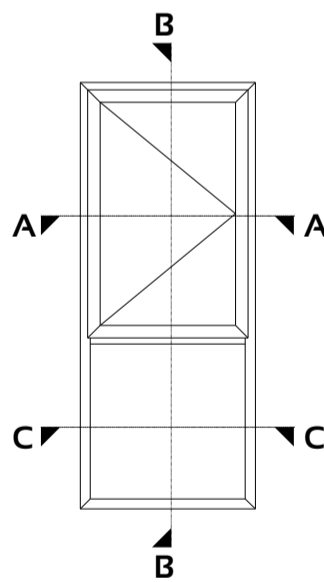
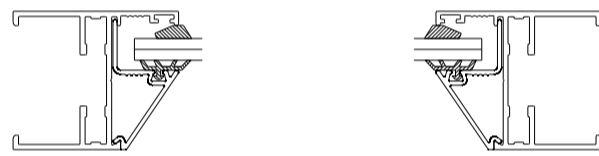

SECTION A-A
Section not to scale

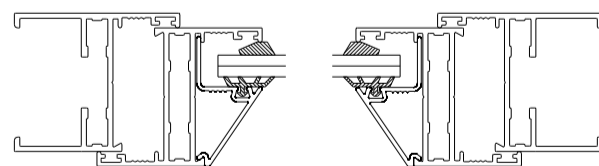

SECTION C-C
Section not to scale



SECTION B-B
Section not to scale

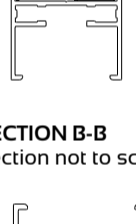
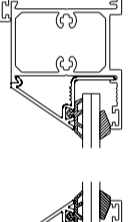
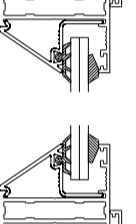
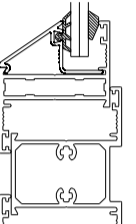
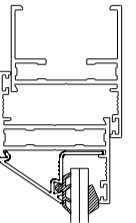

SECTION B-B
Section not to scale

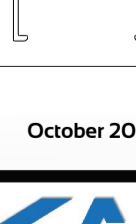
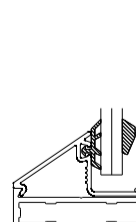
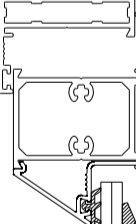

Maximum Sash Sizes (WxH) to suit Friction Stay		
Standard Sash	Top Hung	1500 x 1200
	Side Hung	700 x 1500
Euro Sash	Top Hung	1500 x 1200
	Side Hung	700 x 1500
Double Glazing	Top Hung	1180 x 1200
	Side Hung	700 x 700